

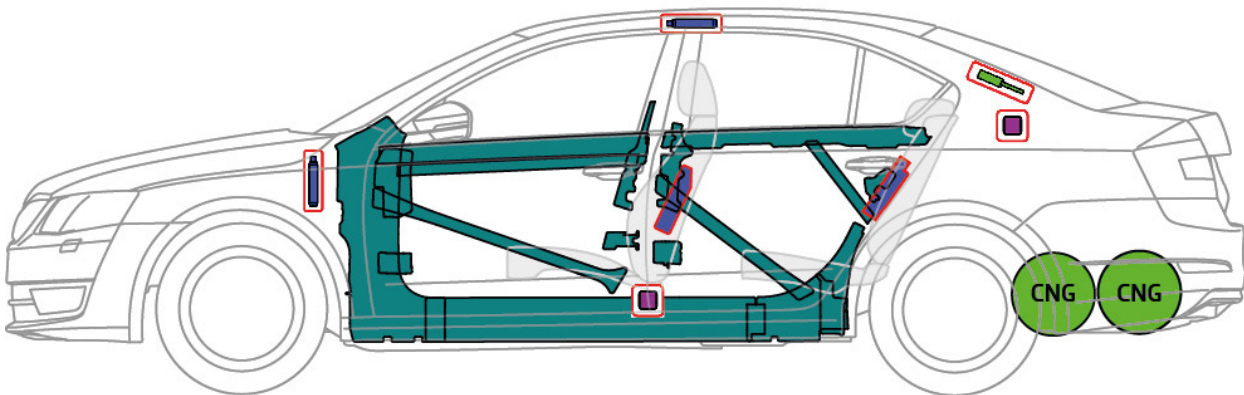

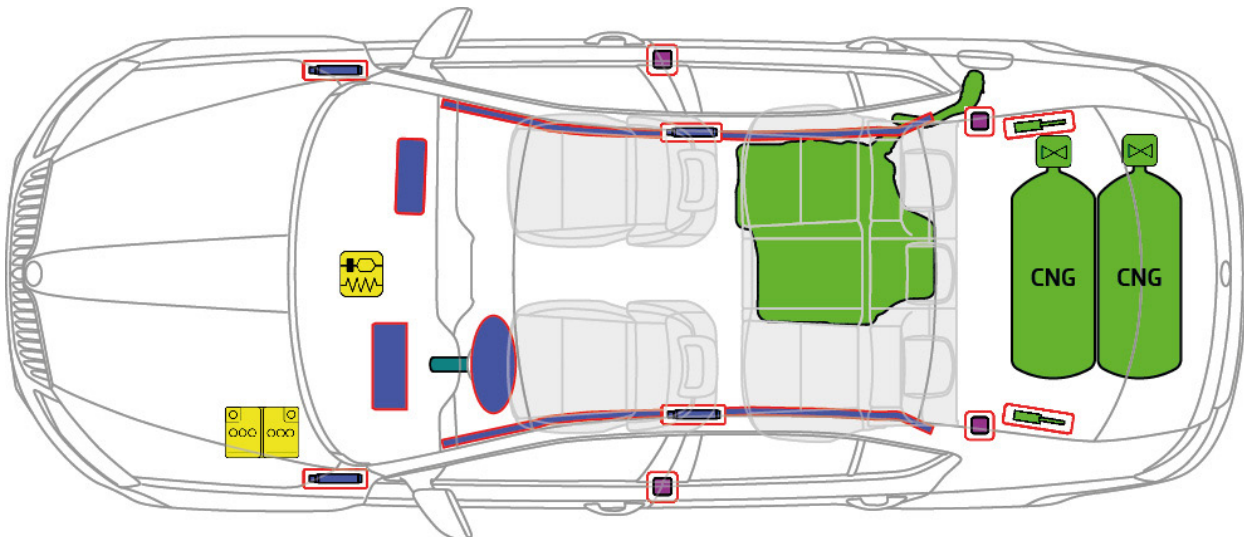







ŠKODA

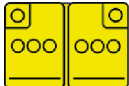

# ŠKODA OCTAVIA III CNG (ab 2014)



Legende

	Airbag		Karosserie-Verstärkung		SRS Steuergerät		Niedervolt-Batterie
	Gasgenerator		Gasdruckdämpfer / vorge-spannte Feder		Treibstofftank		Gurtstraffer
	Sicherheits-ventil		Gastank				

ID-Nummer	Versionsnummer	Versionsdatum	Seite
TMB- 5E	01	02/2016	1 von 1