

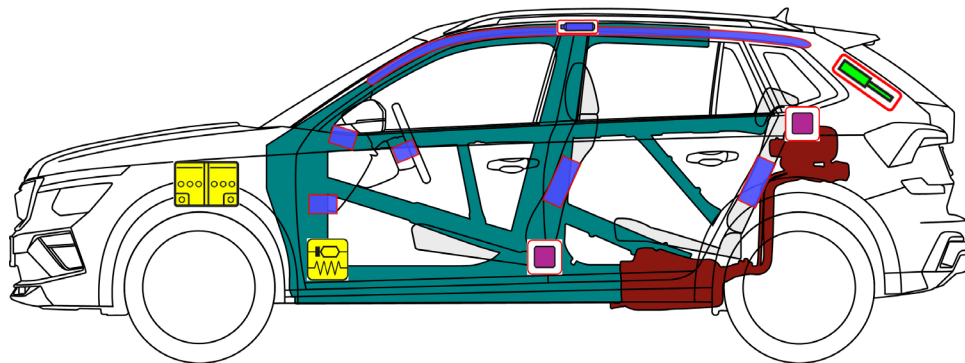

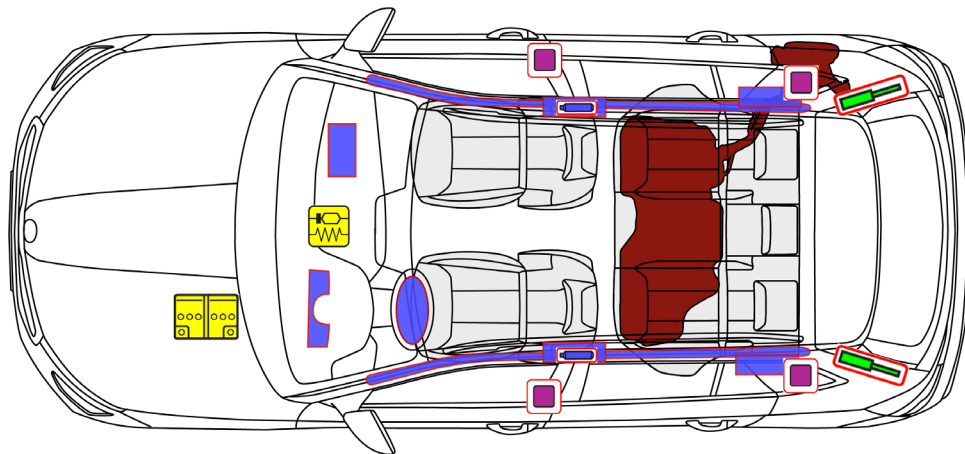





Škoda Kamiq

5 Türen / 5 Sitze / Hatchback
ab 2024



| | | | | | | | | | |
|---|--------------------------------------|---|--------------------|---|---------------------|--|-----------------|---|----------------|
|  | Airbag |  | Gasgenerator |  | Gurtstraffer |  | SRS Steuergerät |  | Treibstofftank |
|  | Gasdruckfeder/ vorgespannte Feder |  | Hochfeste Bereiche |  | Niedervolt-Batterie | | | | |



Škoda Kamiq

5 Tüer / 5 Sitze / Hatchback
ab 2024

1. Identifizierung/Erkennung

Schriftzug



2. Fixierung/Stabilisierung/Heben

Fahrzeug immobilisieren



1. Umschalten auf die Position "P"
2. Feststellbremse anziehen
3. Zündung ausschalten (Powermeter-Anzeige „OFF“)
4. Fahrzeug gegen wegrollen sichern

Hebepunkte

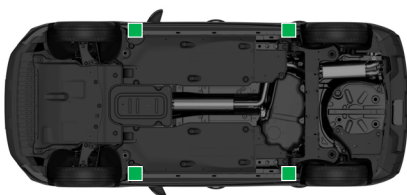

 geeignete Hebepunkte

3. Direkte Gefahren beseitigen/Sicherheitsbestimmungen

Zündung ausschalten



- Zündschlüssel drehen und abziehen oder
- „Engine Start/Stop“ Taste in der Lenksäule drücken ohne Fußbremse zu betätigen.

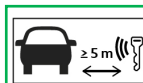

Funkschlüssel möglichst weiter als 5 m vom Fahrzeug entfernen.



12-Volt-Batterie abklemmen



Im Motorraum
Minuspol von der Batterie abklemmen

4. Zugang zu den Insassen

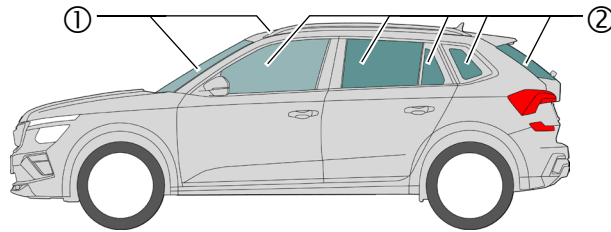

Glastypen:

- ① Verbundscheiben-Sicherheitsglas
- ② Einscheiben-Sicherheitsglas

elektrische Sitzverstellung



mechanische Sitzverstellung



mechanische Lenksäulenverstellung



5. Gespeicherte Energie/Flüssigkeiten/Gase/Feststoffe



Benzin max. 50 l



12 V

6. Im Brandfall

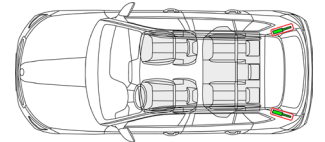

7. Unter Wasser

Nach Bergung das Wasser ablaufen lassen und Batterie(n) abklemmen (siehe Kapitel 3). Entsprechende Schutzausrüstung tragen!



Škoda Kamiq

5 Tüer / 5 Sitze / Hatchback
ab 2024

8. Abschleppen/Transport/Lagerung

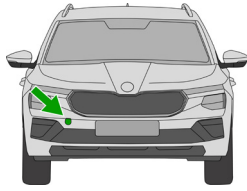

Abschleppöse vorn an rechter Fahrzeugseite

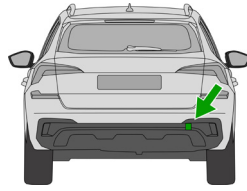

Abschleppöse hinten an rechter Fahrzeugseite



Ein verunfalltes Fahrzeug nicht auf den Antriebsachsen abschleppen.

9. Wichtige Zusatzinformationen

Rettingsleitfaden Škoda: www.skoda-auto.com/services/rescuers

10. Erklärung der verwendeten Piktogramme

| | | | | | | | |
|----------|------------------------|----------------------------|-----------------------|-----------------|-------------------------|------------------------------|--------------------------|
| | | | | | | | |
| brennbar | ätzend, hautreizend | gesundheits- gefährdend | umwelt- gefährdend | Benzin Fahrzeug | Mit Wasser ablöschen | Smart-Schlüssel entfernen | Motorhaube entriegeln |
| | | | | | | | |