

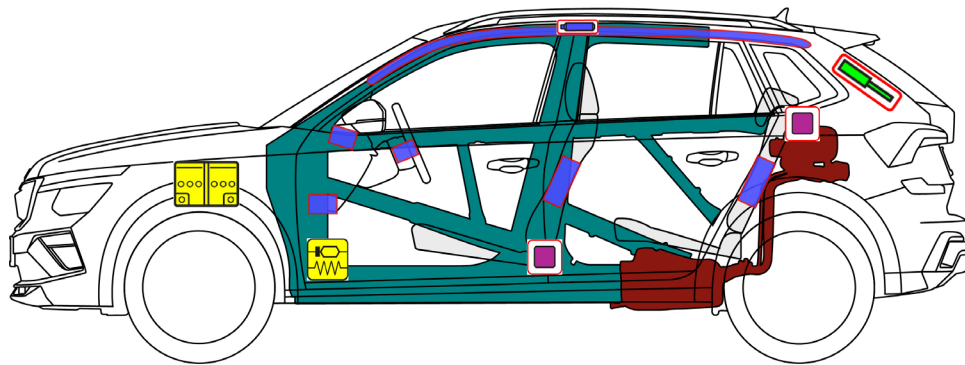

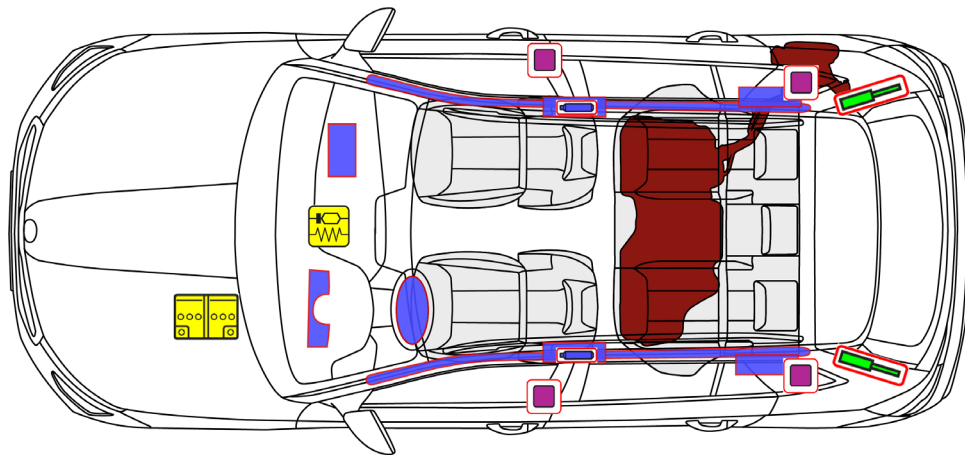







Škoda Kamiq

5-deurs / 5-zitplaatsen / hatchback
vanaf 2024



	Airbag		Gasgenerator		Gordelspanner		SRS-regeleenheid		Brandstoftank
	Gasdrukveer/voorgespannen veer		Zone met hoge weerstand		Lage batterijspanning				



Škoda Kamiq

5-deurs / 5-zitplaatsen / hatchback
vanaf 2024

1. Identificatie / herkenning

Opschrift



2. Immobilisatie / stabilisatie / heffen

Voertuig immobiliseren



1. Stand "P" inschakelen
2. Parkeerrem vastzetten
3. Contact uitschakelen (weergave powermeter "OFF")
4. Voertuig tegen weggrollen beveiligen

Hefpunten

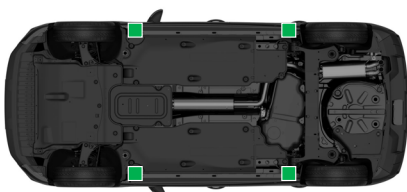

 Geschikte hefpunten

3. Directe gevaren uitschakelen / veiligheidsvoorschriften

Contact uitschakelen



- Contactsleutel draaien en uit het contact trekken of
- knop "Start-Engine-Stop" in de stuurkolom indrukken zonder het rempedaal in te trappen.

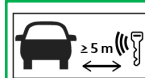

Sleutel met radiografische afstandsbediening indien mogelijk meer dan 5 m van het voertuig verwijderen.



Accukabels van de 12 volt accu losmaken



In de motorruimte

Kabel van de accuinpool losmaken

4. Toegang tot de inzittenden

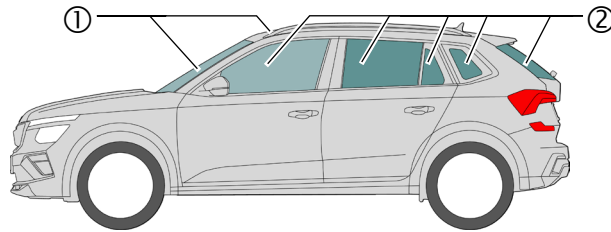

Glassoorten:

- ① Gelaagd veiligheidsglas
- ② Enkellaags veiligheidsglas

Elektrische stoelverstelling



Handmatige stoelverstelling



Handmatige stuurkolomverstelling



5. Opgeslagen energie / vloeistoffen / gassen / vaste stoffen



Benzine max. 50 l



12 V

6. In geval van brand

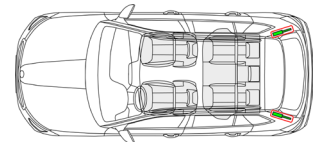

7. In geval van onderdompeling

Na berging het water laten weglopen en de kabels van de accu(s) losmaken (zie hoofdstuk 3). Geschikte veiligheidsuitrusting dragen!



Škoda Kamiq

5-deurs / 5-zitplaatsen / hatchback
vanaf 2024

8. Slepen / transport / opslag

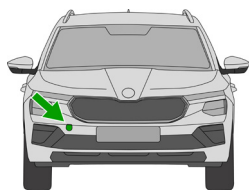

Sleepoog vóór aan rechter voertuigzijde

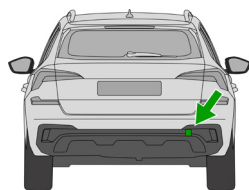

Sleepoog achter aan rechter voertuigzijde



Voertuigen die bij een ongeval betrokken zijn geweest, niet op de aandrijfassen afslepen.

9. Belangrijke bijkomende informatie

Informatieblad voor hulpdiensten Škoda: www.skoda-auto.com/services/rescuers

10. Verklaring van gebruikte pictogrammen

Ontvlambaar	Corrosief	Gevaarlijk voor de menselijke gezondheid	Milieugevaar	Voertuig op brandstof van vloeistofgroep 2	Gebruik water om het vuur te blussen	Slimme sleutel verwijderen	Voorklep ontgrendelen